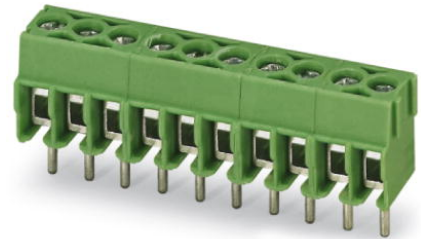

PT 1,5/15-3,5-H

Order No.: 1984743

The figure shows a 10-position version of the product

<http://eshop.phoenixcontact.de/phoenix/treeViewClick.do?UID=1984743>

PCB terminal block, nominal current: 17.5 A, rated voltage: 160 V,
pitch: 3.5 mm, number of positions: 15, mounting type: Soldering,
connection method: Screw connection, connection direction from the
conductor to the PCB: 0°

Commercial data

EAN	4017918946296
Pack	50 Pcs.
Customs tariff	85369010
Weight/Piece	0.00718 KG
Catalog page information	Page 415 (CC-2007)

Product notes

WEEE/RoHS-compliant since:
01/01/2003

<http://www.download.phoenixcontact.com>
Please note that the data given here has been taken from the online catalog. For comprehensive information and data, please refer to the user documentation. The General Terms and Conditions of Use apply to Internet downloads.

Technical data

Dimensions / positions

Length	7.6 mm
Height	9 mm
Pitch	3.5 mm

Dimension a	49 mm
Number of positions	15
Pin dimensions	0,9 mm
Pin spacing	3.5 mm
Hole diameter	1.2 mm
Screw thread	M 2
Tightening torque, min	0.25 Nm

Technical data

Insulating material group	I
Rated surge voltage (III/3)	2.5 kV
Rated surge voltage (III/2)	2.5 kV
Rated surge voltage (II/2)	2.5 kV
Rated voltage (III/2)	200 V
Rated voltage (II/2)	400 V
Connection in acc. with standard	EN-VDE
Nominal current I_N	17.5 A
Nominal voltage U_N	160 V
Nominal cross section	1.5 mm ²
Maximum load current	17.5 A
Insulating material	PA
Inflammability class acc. to UL 94	V0
Stripping length	5 mm

Connection data

Conductor cross section solid min.	0.2 mm ²
Conductor cross section solid max.	1.5 mm ²
Conductor cross section stranded min.	0.2 mm ²
Conductor cross section stranded max.	1.5 mm ²
Conductor cross section stranded, with ferrule with plastic sleeve min.	0.25 mm ²
Conductor cross section stranded, with ferrule with plastic sleeve max.	0.75 mm ²
Conductor cross section AWG/kcmil min.	26
Conductor cross section AWG/kcmil max	16
2 conductors with same cross section, solid min.	0.2 mm ²

2 conductors with same cross section, solid max.	0.34 mm ²
2 conductors with same cross section, stranded min.	0.2 mm ²
2 conductors with same cross section, stranded max.	0.5 mm ²

Certificates / Approvals



CUL

Nominal voltage U _N	300 V
Nominal current I _N	10 A
AWG/kcmil	26-16

UL

Nominal voltage U _N	300 V
Nominal current I _N	10 A
AWG/kcmil	26-16
Certification	CCA, CUL, SEV, UL

Accessories

Item	Designation	Description
------	-------------	-------------

Marking

0804073	SK 3,5/2,8:FORTL.ZAHLEN	Marker card, printed horizontally, self-adhesive, 10-section marker strip, 14 identical decades marked 1-10, 11-20 etc. up to 91-100, sufficient for 140 terminal blocks
0805030	SK 3,5/2,8:SO	Marker card, special printing, self-adhesive, labeled acc. to customer requirements, 14 identical marker strips per card, max. 25-position labeling per strip, color: White

Tools

1205037	SZS 0,4X2,5	Screwdriver, bladed, matches all screw terminal blocks up to 1.5 mm ² connection cross section, blade: 0.4 x 2.5 mm
---------	-------------	--

Drawings

Drilling diagram

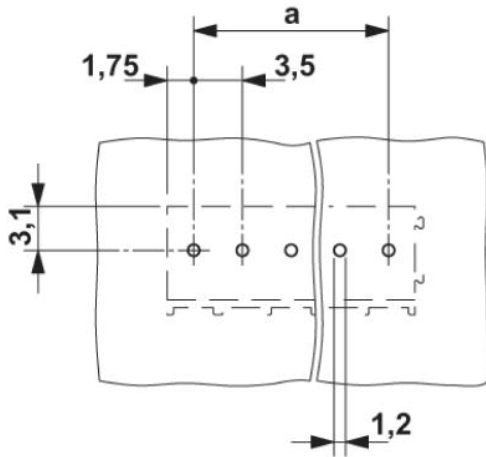

Dimensioned drawing

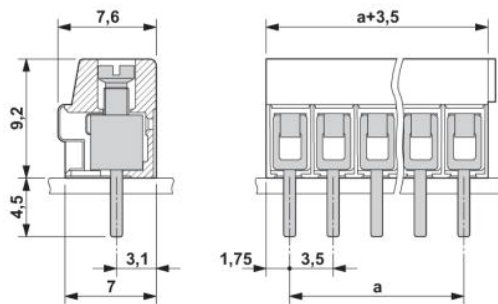

Address

PHOENIX CONTACT Inc., USA
586 Fulling Mill Road
Middletown, PA 17057, USA
Phone (800) 888-7388
Fax (717) 944-1625
<http://www.phoenixcon.com>



© 2008 Phoenix Contact
Technical modifications reserved;